



Superstatic 789

Instruction for Use

Table of contents

1. Notice on this document	3
1.1 Scope of validity	3
1.2 Target groups	3
1.3 Storage of document	3
1.4 Further information	3
1.5 Symbols	4
2. Security	5
2.1 Personel qualification	5
2.2 Intended use	5
3. Scope of delivery, Transport, Storage, Cleaning	7
4. Superstatic 789 thermal energy meter	8
4.1 Dimension qp1.5m ³ /h L = 110 & 130 mm	8
4.2 Dimension qp2.5 m ³ /h L = 130 mm	8
5. Installation	9
5.1 Mounting of the calculator for a cooling application	9
5.2 Wall mounting of the calculator	10
5.3 Mounting of temperature sensors	11
5.4 Sensor pockets overview	12
5.5 Direct mounting in a T tube	12
5.6 Fitting temperature sensor for cooling application	12
6. Installation of the thermal energy meter	13
6.1 Superstatic 789	13
6.2 Mounting of the cable for the pulse input function	13
6.3 Mounting of the cable for the pulse output function	13
7. Commissioning	14
7.1 Commissioning from the storage mode	14
8. Error codes	15
9. Display	15
9.1 Display sequence	16
9.2 Detailed display sequences	16
10. Communication	17
10.1 SONTEX Radio	18
10.2 wM-Bus Radio / OMS	18
10.3 LoRaWAN	18
10.4 Powered M-Bus	19
11. Security seals	19
12. Technical data	20
12.1 Superstatic 789	20
12.2 Pressure loss curve	20
12.3 General technical data	21
13. Declaration of conformity	22

1. Notes to this document

This manual provides all the information required for the correct use of the equipment: From product identification, installation and commissioning to troubleshooting, maintenance and disposal.

1.1 Scope of validity

This documentation is valid for the Sontex Superstatic 789.
The case of specific details for Superstatic 789 will be explained as a note in the current manual's different sections.

1.2 Target groups

This documentation is intended for the system operator and the installer.

1.3 Storage of the document











The system operator must ensure that this documentation is accessible to the responsible persons at all times. If the original document is lost, you can download an up-to-date version of this document from our Website

<https://sontex.ch/en/applications/building-automation/#superstatic-789>

1.4 Further information

Links to further information can be found at www.sontex.ch.

1.5 Symbols

Symbol	Significance
	DANGER! Warning, the non-observance of which leads directly to death or serious injury.
	WARNING! Warning, the non-observance of which may result in death or serious injury.
	CAUTION! Warning, the non-observance of which may result in minor or moderate injury.
	NOTICE! Warning, the non-observance of which may result in damage to property.
	Reference Information that is important for a specific topic or goal, but not relevant to security.
	Documentation Reference to documentation.
	Help Help in case of problems.
	Visual check Check that the item is in order.
	CE and UKCA-Marking The device meets the requirements of the European directives and of the UK Conformity Assessment.
	Disposal This symbol indicates that electrical and electronic equipment must be disposed of separately. Do not dispose the device with household waste.

2. Security

WARNING

Improper installation, pressure tests, modifications or incorrect operation can cause personal injury and damage to property.



Pressure surges in the pipeline can damage the meter!
Existing air pockets falsify the measuring result.

- If the seal is damaged or removed, the compact thermal energy meter is no longer approved for legal metering or legal measurement.
- Before installation, check compact thermal energy meter for transport damage.
- Do not drop, never hold on to the protective cover of the counter.
- If the compact thermal energy meter has been dropped, it must not be installed again.
- Only use suitable lubricants for seals.
- Compact thermal energy meters may only be installed after a pressure test.
- Compact thermal energy meter may only be installed in pipelines that have already been leak-tested, rinsed and must be well vented before commissioning.

2.1 Personnel qualification

The compact thermal energy meter may only be installed or replaced by qualified personnel for sanitary, heating and air-conditioning technology.

2.2 Intended use



The compact thermal energy meter Superstatic 789 is a precision measuring instrument approved for individual metering of heating systems and must be handled with care.

The Superstatic 789 is available in a heating or cooling or heating/cooling version and determines the thermal and/or cold energy exchanged by a heat-bearing fluid in a heat exchanger circuit.

The Superstatic 789 complies with the requirements of the European Directive MID 2014/32/EU modules B and D and of the standard EN 1434 class 2.

NOTICE

The thermal energy meter must be used within the conditions indicated on the meter; the metrological seals have to stay intact.

In the event non compliancy to these conditions, the device may be destroy and the manufacturer declines all liability, warranty and guarantee for correct metrology.

The manufacturer will not be liable in the event of any modification of the metrological data or of the measurement parameters if any of manu-facturer's seals is damaged. The seals can only be applied by authorised people in conformity to national legislation related to legal metrology.

Use only the accessories provided by the manufacturer.

For cleaning, a moist cloth is sufficient. Do not use solvents.

Do not shorten the cable between the flow meter and the calculator and the cables for the temperature sensors or modify them in any way whatsoever.

NOTICE

Before installation

- Check the installation data and compare them with the specific characteristics of the thermal energy meter.
- The rules for installation and those relating to the project must be respected.
- The environmental temperature range for the energy meter is 5...55 °C.
- Make sure that the meter and the labels can be read easily.
- All connections must be made at a minimum distance of 300 mm from high frequency or high voltage cables. Avoid thermal radiation and interfering electrical fields near the calculator and connection cable.
- As a rule, the calculator must be installed at a distance from pipes carrying refrigerating fluids.
- Action must be taken to ensure that no condensation water can penetrate inside the calculator.
- If there is any risk of vibrations, the calculator must be installed separately on the wall.
- If the temperature of the fluid within the flow meter regularly reaches 90°C, the calculator must be installed separately from the flow meter.
- It is advisable to drain the installation before fitting the flow meter. This will allow that any foreign body is withdrawn from the pipe.

WARNING

Security with lithium batteries

3V lithium batteries are used. Certain security rules must be respected: the replacement of batteries or to add a second battery is not allowed. During recycling, the following points must be respected: Do not recharge or short-circuit, protect against humidity, do not expose to heat, do not throw batteries in fire, keep out of reach of children.

3. Scope of delivery

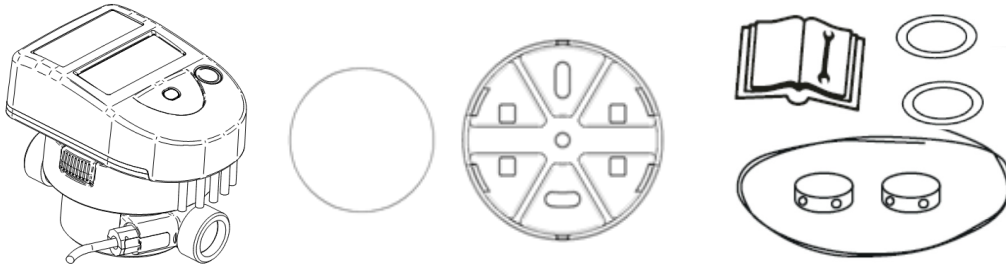

Transport



Storage

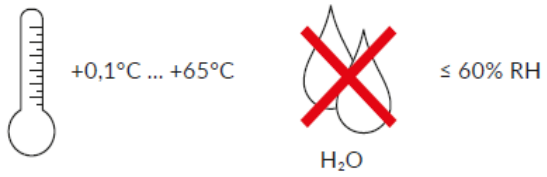

Cleaning



4. Superstatic 789 thermal energy meter

4.1 Dimension qp1.5 m³/h L = 110 / 130 mm

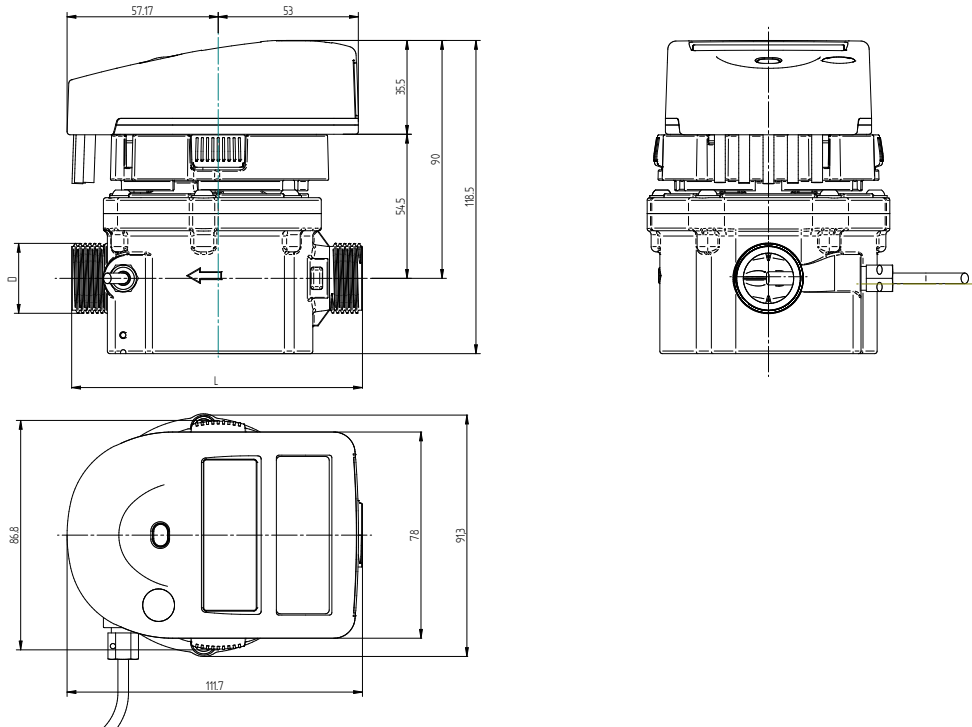

4.2 Dimension qp2.5 m³/h L = 130 mm

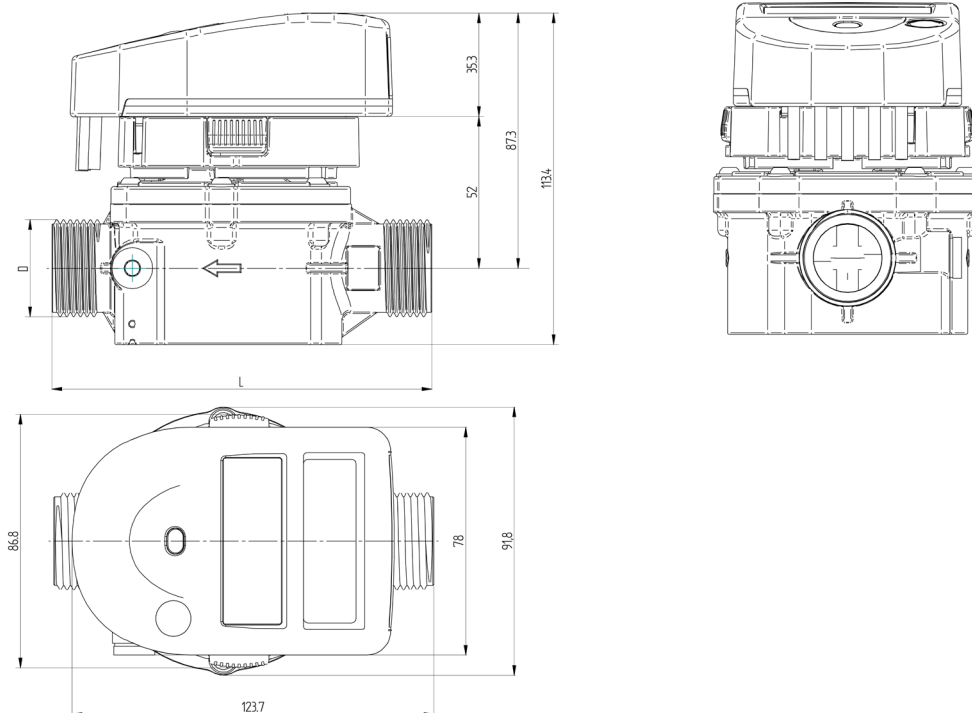

5. Installation



The prescriptions related in the standard EN1434-6 must be respected when the Superstatic 789 is installed.

In the standard version, the calculator is parameterised by default for installation on the “cold” pipe side. Installation on the “hot” pipe side must be specified with the order. Depending on version and use (heat and/or cooling meter), the energy meter must be fitted on the “cold” or “hot” pipe side of the installation in compliance with the chosen configuration. If the device was ordered with the configuration option, some parameters can be changed using the “Config” menu during commissioning.

In a same installation, mixed mounting positions (horizontal and vertical) can be realized. Place the flow meter correctly according to the direction of the fluid (an arrow ← can be seen on the flow meter).

Horizontal mounting with the integrator facing downwards is not permitted. Also avoid fitting in a position which may cause an air bubble to build up inside the mechanical meter.

The energy meter must be fitted between two shutoff valves. The flow meter must be installed ahead of any monitoring valves so as to avoid any potentially interfering influence. Waterproof will be checked at the various mounting points.

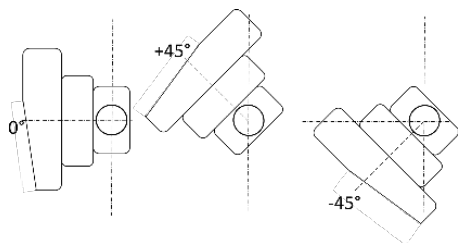

Horizontal mounting position:

The sensor head MUST be placed to the side +/- 45° in relation to the pipe axis to avoid influences of air inclusions (top) or dirt (bottom).

Vertical mounting position:

Mounting in riser or down pipes possible.

The heat conveying liquid must be equivalent to water without any additives according to standard FW510 of the AGFW (German District Heating Association). If additives are added to the water, the user must ensure the compatibility of the materials used in the thermal energy meter which are in contact with these additives.

5.1 Mounting of the calculator for a cooling application

Only the flow meter can be fully isolated. Separate the calculator from the flow meter and fix using the wall support aid.

It is recommended to separate the calculator from the flow meter and installed at a sufficient distance from the flow meter if:

- The meter has to be installed in a confined space
- The meter is in connection with mounting in condensing environments
- To prolong the battery life time

The pipes are generally free from air before the installation is brought into service. Follow the insulation instructions for cooling installations. Final commissioning must be performed and documented.



After mounting and before commissioning purge system > 10 min at qp to avoid air bubbles.

5.2 Wall mounting of the calculator

The calculator can be separated from the flow meter and fixed against a wall using the wall fixing component, together with a double-sided adhesive tab delivered with the Superstatic 749 (Figure 1). If possible, install the wall fixing component above the flow meter. The wall fixing component can also be screwed on to the wall (screws are not supplied).

To separate the calculator from the flow meter press laterally with one hand on the two locking buttons, while pulling the calculator upwards (Figure 2).

Fix the calculator onto the wall fixing component taking care not to jam the cable which connects the calculator to the flow meter and stick the adhesive tab behind the wall component. Secure the assembly to the wall (Figure 3).

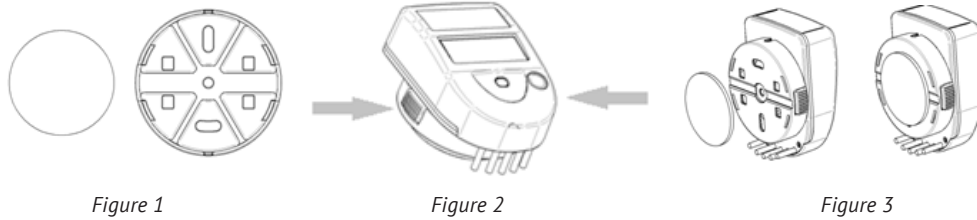

To remove the calculator from the wall support, it will be sufficient to press laterally on the two locking buttons while pulling the assembly towards you.

Rewind the connection cable at the position provided for this purpose on the flow meter (1) and reinsert the calculator (2).

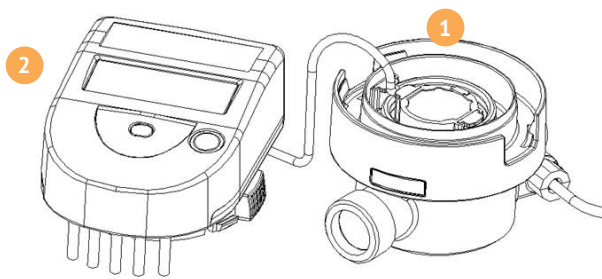

5.3 Mounting of the temperature sensors

The temperature sensor in the flow meter has no black frame marking on the label.

The temperature sensor with the black frame mark on the label indicates that the sensor must be mounted in the pipe “opposite” to the Superstatic 789.

Example: If the flow meter is installed on the warm side (Hot Pipe), the temperature sensor with the black frame mark will be mounted in the cold side (Cold Pipe).

The Superstatic 789 is delivered with temperature sensors having a cable length of 1.5 m. The temperature sensors form a sub-assembly with the calculator. The temperature sensor cables must be neither shortened nor lengthened. The temperatures of use displayed on the label must be respected.

A temperature sensor may be fitted directly in the Superstatic 789 flow meter. The temperature sensors will preferably be fitted directly, in other words one temperature sensor will be fitted in the flow meter while the other sensor will be installed on the other side of the heat exchanging circuit.

Note: The temperature sensors will be fixed with a plastic nut. This plastic nut consists of two half-nuts held together by a rubber band. If the rubber band is removed from the nut, the two nut halves will no longer be held together on the temperature sensor and one or both nut halves may separate from the temperature sensor.

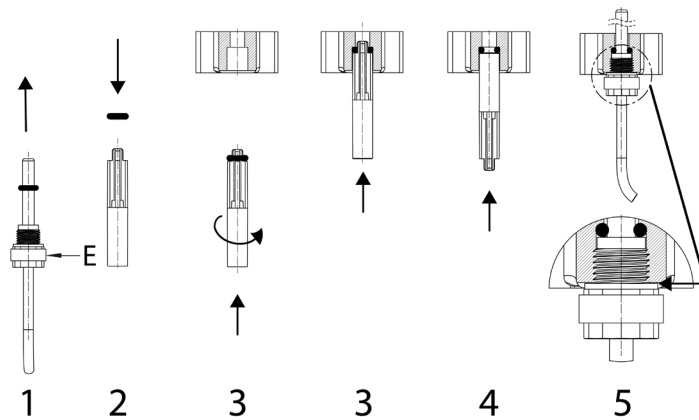

1. Remove the O-ring from the temperature sensor. Be careful not to remove the rubber band (symbolized by the letter "E" on the drawing) from the nut as it may separate into two parts and fall on the floor.
2. Fit the O-ring on the mounting template pin.
3. Insert the O-ring by rotating it using the fitting template in the position provided for the ball valve.
4. Position the O-ring definitively with the other flat end of the fitting template.
5. Insert the temperature sensor with the two half-nuts in the thread M10x1 of the ball valve and screw down by hand as far as it will go (maximum tightening torque of 1 Nm).

Note: The mounting template pin is not included in the delivery and can be ordered separately (Article number: 0460P348).

When sensor pockets are employed, these must be used specifically for the two temperature sensors and must correspond to the list set out below.

Asymmetrical mounting is also possible. In that case the temperature sensor having a cable marked with black frame will be fitted in the other side of the heat exchanging circuit in a sensor pocket defined according to the table set out below.

For applications with non-symmetrical integrated temperature sensor pair restricted rated operating conditions are to be in accordance with the lower limit of the flow value and the lower limit of the temperature difference: $q_i \geq 200$ l/h at $\Delta T_{min} = 3$ K or $q_i \geq 60$ l/h at $\Delta T_{min} \geq 6$ K.

Make sure that the sensors are mounted until they stall with the bottom of the sensor pocket.

5.4 Sensor pocket overview

Temperature sensors	Versions	Pocket	Art.-N°	Material	Temperature range
Ø 5x31 mm	Pt1000	M10x1	0460A212	Brass	0...100 °C
Ø 5x 31 mm	Pt1000	G3/8"	0460A213	Brass	0...100 °C
Ø 5x 31 mm	Pt1000	G1/2"	0460A214	Brass	0...100 °C
Ø 5.2x 31 mm	Pt1000	M10x1	0460A215	Brass	0...100 °C
Ø 5.2x 31 mm	Pt1000	G3/8"	0460A216	Brass	0...100 °C
Ø 5.2x 31 mm	Pt1000	G1/2"	0460A217	Brass	0...100 °C
Ø 6x 31 mm	Pt1000	M10x1	0460A201	Brass	0...100 °C

Sensor pockets for Universal temperature sensors (with composite fitting)					
Ø 5	Pt1000	M10x1	SCTW4A1	Brass	0...100 °C
Ø 5	Pt1000	G3/8"	SCTW4A2	Brass	0...100 °C
Ø 5	Pt1000	G1/2"	SCTW4A3	Brass	0...100 °C
Ø 5.2	Pt1000	M10x1	SCTW4A4	Brass	0...100 °C
Ø 5.2	Pt1000	G3/8"	SCTW4A5	Brass	0...100 °C
Ø 5.2	Pt1000	G1/2"	SCTW4A6	Brass	0...100 °C
Ø 6	Pt1000	G1/2"	SCTW1A1	Brass	0...100 °C

5.5 Direct mounting in a T tube

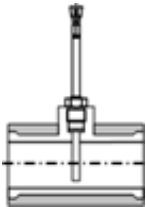

The temperature sensor is on the same level and perpendicular to the pipe axis (DN15, DN20)

5.6 Fitting temperature sensors for refrigeration applications

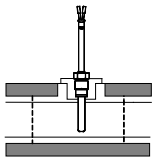

Insulation will only be provided as far as the fixing screw

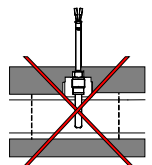

NOTICE

The temperature sensor fixing screw must not be covered by any kind of insulation. This likewise applies if the sensor is fixed directly in the flow meter.

6. Installation of the thermal energy meter

6.1 Superstatic 789

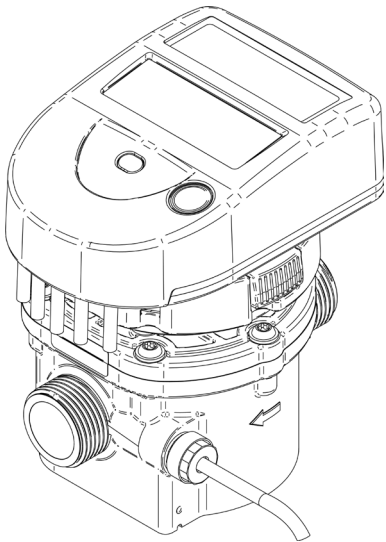

To install the Superstatic 789, the following steps must be respected:

- Flush out the installation pipes carefully in compliance with the DIN/EN standard specification.
- Close the shutoff valves before and behind the meter.
- Open the drainage valve to reduce the pressure and discharge the water contained in the pipe between the two shutoff valves.
- Consider the direction of flow circulation. Check the flow direction with the arrow figuring on the flow meter.
- Place a gasket on each side of the flow meter. Only use appropriate new gaskets.
- Make sure that the gaskets are carefully positioned in relation to the water pipe and flow meter unions.
- Tighten the fixing nuts firmly by hand. Then tighten up to the mechanical end stop using a mounting tool.
- Install the temperature sensor.
- Turn the display into the desired position for reading.
- Check the waterproof of the meter placed under pressure.
- Seal the flow meter and the temperature sensors.

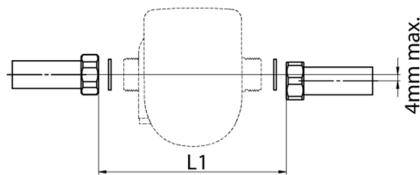

Precautions to be observed during the mounting :

- Between the axis of the pipes an offset (misalignment) of 4mm maximum is tolerated
- Use only the EPDM gaskets supplied with the Superstatic 789.
- Tightening of the two fixing nuts will be done with a torque wrench with a maximum tightening torque of:
 - 25 Nm for flow meter qp1,5 m³/h G ¾" (DN15).
 - 25 Nm for flow meters qp1,5 m³/h G 1" (DN20) and qp2,5 m³/h G 1" (DN20).
- Mounting distance L1 for the flow meter:
 - L = 110 mm, qp1,5 m³/h G ¾" (DN15) :
L1 = 113 ± 1mm
 - L = 130 mm, qp1,5 m³/h and qp2,5 m³/h G 1" (DN20) :
L1 = 133 ± 1mm

6.2 Mounting of the cable for the pulse input function

The pulse inputs are built with SELV circuits (Safety Extra Low Voltage) and must be only connected with SELV circuits. The electrical characteristics are displayed on page 21.

6.3 Mounting of the cable for the pulse output function

The pulse outputs are built with SELV circuits (Safety Extra Low Voltage) and must be only connected with SELV circuits. The electrical characteristics are displayed on page 21.

7. Commissioning

7.1 Commissioning from the storage mode

Ex works the flow meter can be in the storage mode, that is to say, it does not count and the display shows "Disabled".

The storage mode is active as long as the meter is not sealed "Seal".

In the storage mode, the transition to "Config" menu is made with a short press on the orange navigation button. Another short press gives access to the whole sequence of the "Normal" mode.

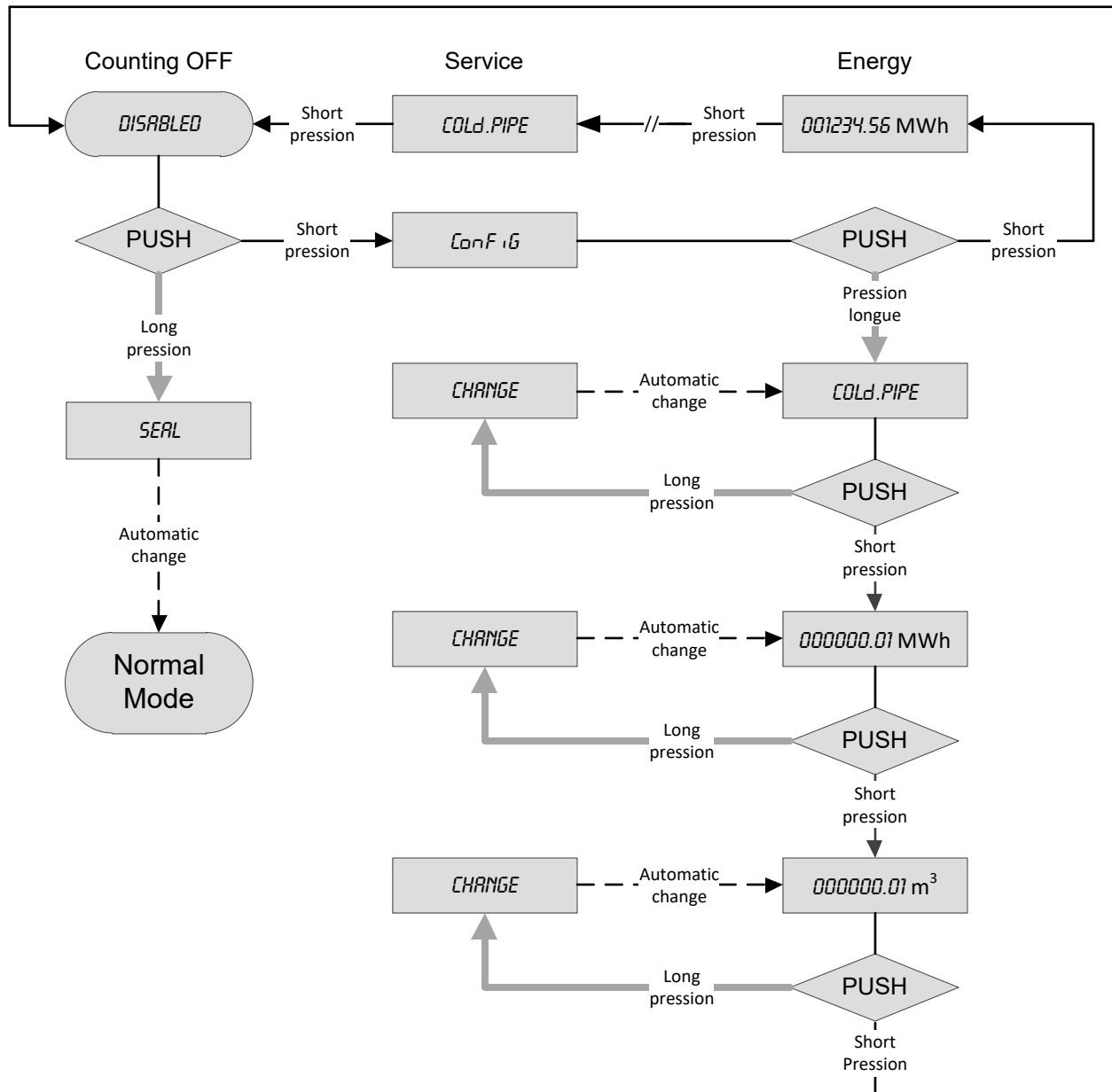

In the "Config" menu (optionally available), a long press will change the settings below:

- Flow meter mounting position in the installation. Hot (HOT PIPE) or cold side (COLD PIPE).
- Energy unit (0.1kWh, 1 kWh, 0.001MWh, 0.01MWh, 0.001GJ and 0.01GJ).
- Volume unit (0.01 m³ and 0.001m³).

In the "Config" menu any inaction (i.e. with no pressure on the navigation button) lasting 3 minutes causes the automatic exit and returns to "Disabled". If changes were made in the "Config" menu, the data remain stored

NOTICE

When "Disabled" is displayed, a long press on the navigation button validates the parameters of the flow meter. The indication "Seal" flashes four times on the display and it changes to "Normal" counting mode.

From that moment, the storage mode ("Disabled" and "Config") is not accessible anymore.

Checking operation

Make sure that the measurements indicated by the meter are coherent using the orange button which you will find on the meter. The following values can be shown on the LCD display: flow, power, hot and cold temperatures. The communication arrows permit display of the controls (inputs) and responses of the instrument (outputs). **All the display parameters will be used to check and adjust the installation. In particular, you must make sure that the maximum flow rate of the installation does not exceed the maximum flow rate authorised for the meter. To complete the functional analysis, the commissioning protocol can be saved using the Prog7x9 software via the optical interface.**

8. Error codes

The Superstatic 789 calculator displays an error message with the 3 letters "Err" and a code. If several errors occur at the same time, the different codes are added together.

The error is displayed in the first position of the display menu. It will still be possible to select all the other display menus by pressing the navigation button. If the navigation button is no longer pressed for a period of 3 minutes, the error code will automatically appear again in the first position of a display menu.

Display of an error automatically disappears when the error is no longer present.

- Err 1: Flow higher than $1.2 \times q_s$ or defective hydraulic sensor.
- Err 2: Measured temperature outside the homologated range or temperature sensor defective.

To make sure that the temperature sensors have not been cross during assembly, the temperature difference between the outward and return temperatures can be checked on the display. Depending on the use (thermal or refrigerating), this temperature difference may be either positive or negative.

9. Display

The Superstatic 789 LCD display has been designed to be large enough and perfectly readable by the user.

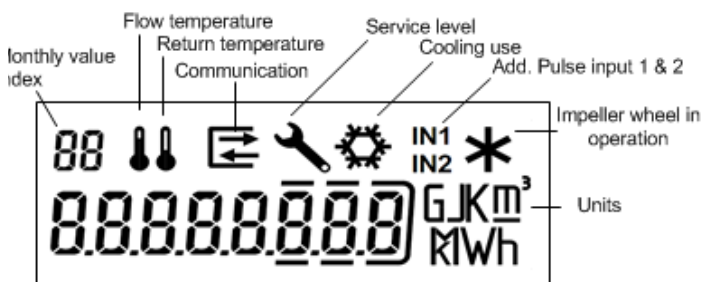

9.1 Display sequence

To display general data on the calculator, several windows have been created in the form of menu/sub-menu functions. Depending on the chosen version of the energy meter, some menus may be added.

The “Energy” window of the main menu is the basic display.

The navigation button enables the user to change from one menu to another and to access the different positions within a menu.

Short pressure on the navigation button permits transition from one menu to another or continuation to the next display while remaining in the same menu.

Long pressure (> 2 seconds) on the navigation button gives access to sub-menu within a menu or enables the “Energy” window to be displayed from within a menu.

After 3 minutes, the display automatically reverts to the basic “Energy” window.

9.2 Detailed display sequences in Normal Mode

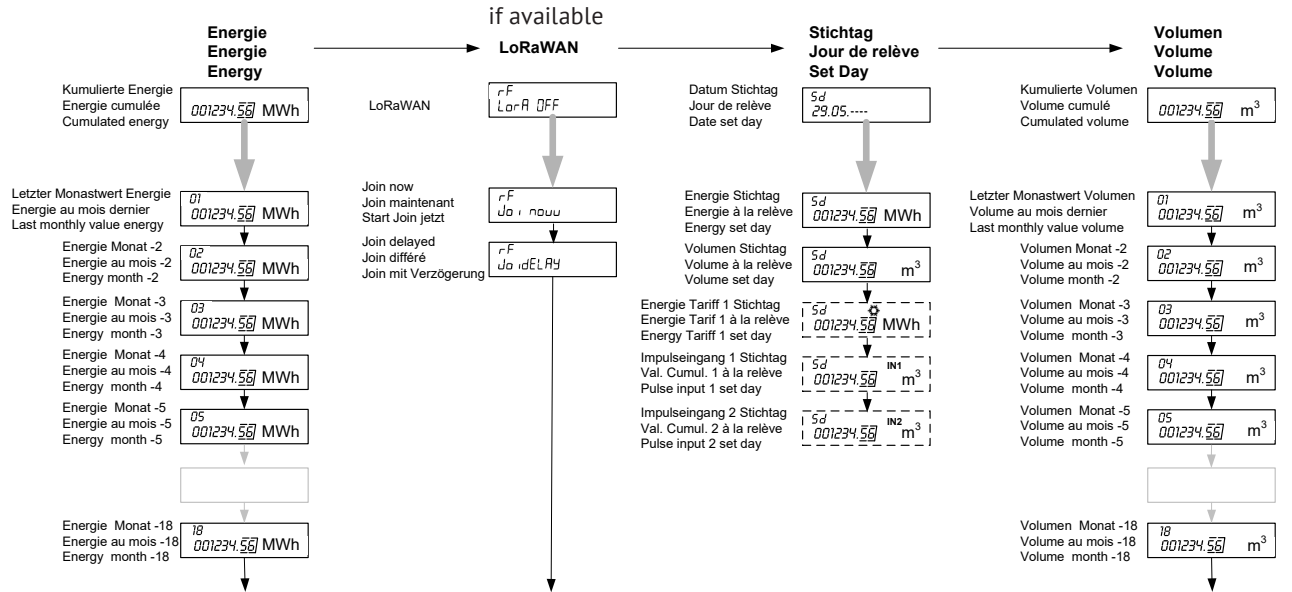

...and continues.....

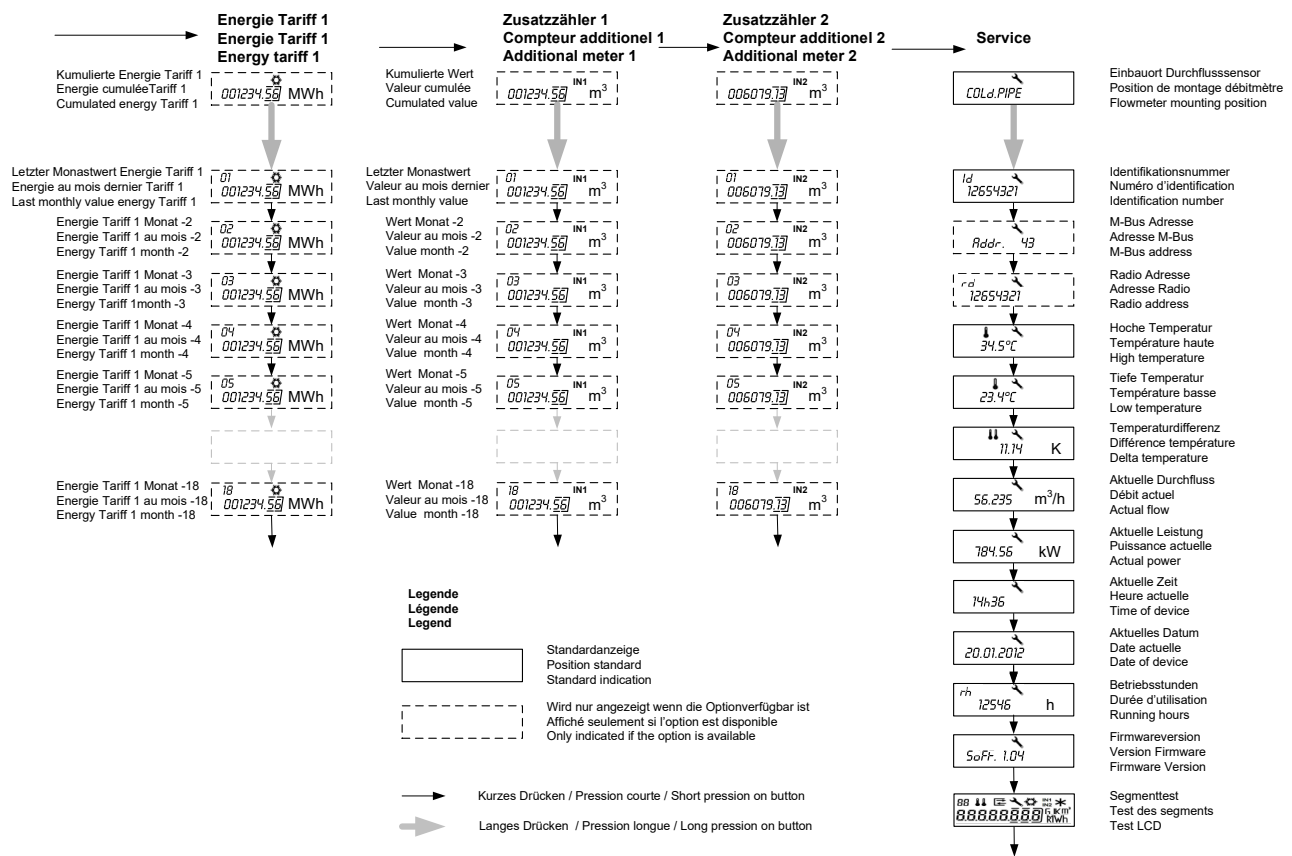

10. Communication interfaces and options

The communication interfaces are installed and preset in the factory. When ordering, you must specify the interface type: remote powered M-Bus or Radio SONTEX, Wireless M-Bus (OMS), LoRaWAN, or pulse outputs.

Pulse input function

The Superstatic 789 offers the possibility of integrating up to two further pulse input from other meters, for instance a hot water and a cold water meter.

The value of the pulse factor is programmable via the Prog7x9 software. By default, the pulse factor will be 1 Pulse/Unit for each pulse input.

The meter data are aggregated separately in totalizers and can be shown on the display as IN1 and IN2; they can also be transferred via the communication interface which is installed in the calculator. The Superstatic 789 is delivered with a cable length of 1.5 m for the input pulse signals.

Pulse output function

If ordered the Superstatic 789 offers the possibility of integrating two open collectors pulse outputs which can represent hot energy, cold energy or volume.

Energy Meter – heating or cooling application:

- Output S1 = Heating or cooling energy
- Output S2 = Volume

Mixed application heating and cooling:

- Output S1 = Heating energy
- Output S2 = Cooling energy

Whenever the smallest energy unit (hot or/and cold) or volume displayed on the screen is incremented, 1 pulse will be transmitted on the corresponding output cable S1/S2.

Example for energy:

Display 12345678 kWh ==> output pulse value for energy = 1 kWh / pulse

Display 12345,678 MWh ==> output pulse value for energy = 0.001 MWh / pulse

Display 123456,78 GJ ==> output pulse value for energy = 0.01 GJ / pulse

Example for volume:

Display 12345,678 m³ ==> output pulse value for volume = 0.001 m³ / pulse

Display 123456,78 m³ ==> output pulse value for volume = 0.01 m³ / pulse

The Superstatic 789 is supplied with a cable length of 1.5 m for pulse outputs.

Electrical characteristics of the pulse outputs: open collector 1 Hz 500 ms.

Optical interface

The optical interface is available on every Superstatic 749.

Communication between the Prog7x9 software and Superstatic 749 can be done by means of an optical coupler.

The Prog7x9 software is mainly used to configure the non-metrological parameters and for readout.

The transmission speed is set at 2400 bauds and cannot be changed.

We recommend the use of optical couplers supplied by: www.pettechnik.de

Should communication problems occur, please refer to the document User Guide Prog7x9 (integrated as PDF in the software).

For the optical probe listed below, we have noted the filters needed to permit correct communication with Prog7x9 software:

Optical probe	Filter
P+E Technik : "K1-98" or "K1-06"	No filter
P+E Technik : "K01-USB"	No filter

10.1 SONTEX Radio

The SONTEX Radio communication interface supports communication between all Sontex products having this interface. It must be specified when ordering. The radio module will then be installed and configured in the factory.

The SONTEX Radio interfaces make use of a bidirectional radio technology which is a highly reliable and performant solution for a remote metering system (fixed or mobile). The technology employed is based on Radian 0 protocol and works at a frequency of 433.82 MHz.

The products fitted with this Radio module can be accessed 365 days a year from 06:00 to 20:00. The radio address is displayed in the Service menu if it corresponds to the serial number of the Superstatic 789.

Technical data

Bidirectional communication; FSK Modulation; Frequency 433.82 MHz; Radian 0 radio protocol, transmission power: 10 dBm (10 mW)

The life cycle is calculated for normal metering. Factors such as: the environmental temperature during use, the number of readings taken etc. influence the battery service life.

10.2 wM-Bus Radio / OMS

The Wireless M-Bus module is used to transfer data according to the wM-Bus (EN13757-4) radio communication protocol and in compliance with the OMS (Open Metering System) Release V4. To have this interface provided in the Superstatic 749, it is necessary to specify when ordering. The Wireless M-bus module will be installed and configured at the factory. A specific notice will be added to the standard documentation.

Technical data

Unidirectional communication, Frequency 868.95 MHz, Encryption mode 5 or 7, Radio telegram C1 or T1, transmission power: 14 dBm (25 mW).

10.3 LoRaWAN®

A LoRa enabled device can be identified as such if the product label is marked "LoRa". First of all, the LoRa device must be registered on a LoRaWAN network.

The registration of the device on the network will be done by a JOIN request that can be started from the Prog7x9 software or directly on the device via the LCD screen.

To register the device on the network, please follow the sequence below:

Technical data

Bidirectional communication, Frequency EU868, transmission power: 14 dBm (25 mW)



By briefly pressing the orange button, look for "LorA OFF" in the menu.

Long press to confirm



You can choose the option "Join now" (JoinNow):

Long press to confirm or press the orange button briefly to..



... start the delayed registration procedure (JoinDelay) (by default 30 sec) and display "JoinDelay"

Long press to confirm.

10.4 Powered remote M-Bus

The powered remote M-Bus communication interface is a serial interface which permits communication between different M-Bus devices via a central M-Bus station. It must be specified when ordering. The powered remote M-Bus module will hence be installed and configured in the factory.

By default, the primary address will be configured with the address 0 and the secondary address will correspond to the serial number of the Superstatic 789. To change the value of the secondary address, you must use the Prog7x9 software or send M-Bus specific orders. The secondary address corresponds to the identification field ID. The primary address is displayed in the Service menu with the indication [Addr:].

Technical data for the M-bus communication system:

M-Bus protocol compliant with standard EN 1434-3; free potential interfacing without polarity (the voltage measured on the last device must exceed 36VDC); transmission speed 300/2400 Baud; variable data structure. A M-bus device is seen as two M-Bus charges by the Master.
Type of cable recommended: telephone cable JYStY N*2*0.8 mm²

11. Security seals

As sealing varies from country to country, local regulations must be followed. To protect the system against all unauthorised manipulations, the energy meter, the connection screws, the temperature sensors and the sensor pockets must all be sealed. The seals may only be removed by authorised persons. In the event of failure to comply with this instruction, the guarantee obligation will lapse. It is important for the wire seal to be as short as possible so that it is slightly taut. This is the only way of preventing malicious interference.

A factory seal will be applied to the temperature sensor mounted in flow meter. To mount the temperature sensor on the other side of the installation, the Sontex sticker seal (S written in black on a grey background) or wire seal supplied with the meter must be used. The detector support fitted on the flow sensor can't be removed without being damaged or broken.

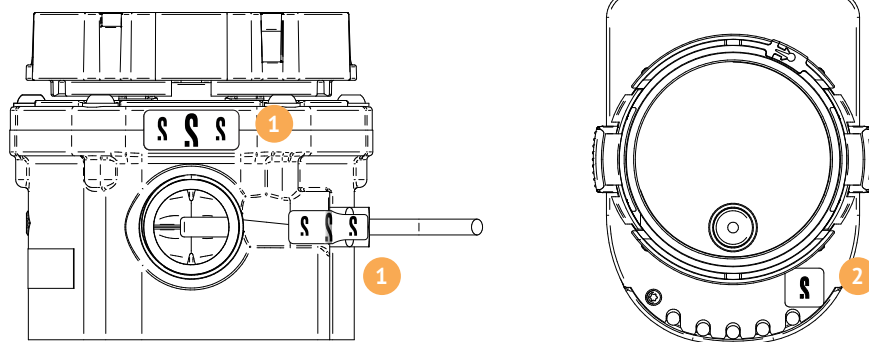

- 1 Seals installed in the factory on flow meter and temperature sensor of the Superstatic 789
- 2 Seal installed in the factory on the calculator

12. Technical data

12.1 Superstatic 789

Qn	Threaded connection		Mounting length	Mat	PN	Maximal flow qs	Minimal flow qi	Low flow threshold value (50°C)	Threaded hole for sensor	Total Meter Weight	Kvs value (20°C)	Pressure loss at qp
	G"	DN										
	(EN ISO 228-1)											
1.5	3/4"	(15)	110	Comp	16	3.0	15	10	yes	0.72	3.4	0.20
1.5	1"	(20)	130	Comp	16	3.0	15	10	yes	0.74	3.4	0.20
2.5	1"	(20)	130	Comp	16	5.0	25	17	yes	0.75	5.6	0.20

Comp = High-tech composite 16 bar = 1.6 MPa

Mounting

The Superstatic 789 should not be mounted on the side where the continuous operating temperature of the liquid exceeds 90°C or is below 5°C.

Length of straight section fitted upstream/downstream of each flow meter (EN1434):

U3 / D0 for: L = 110mm

U0 / D0 for: L = 130 mm

12.1 Pressure loss curve

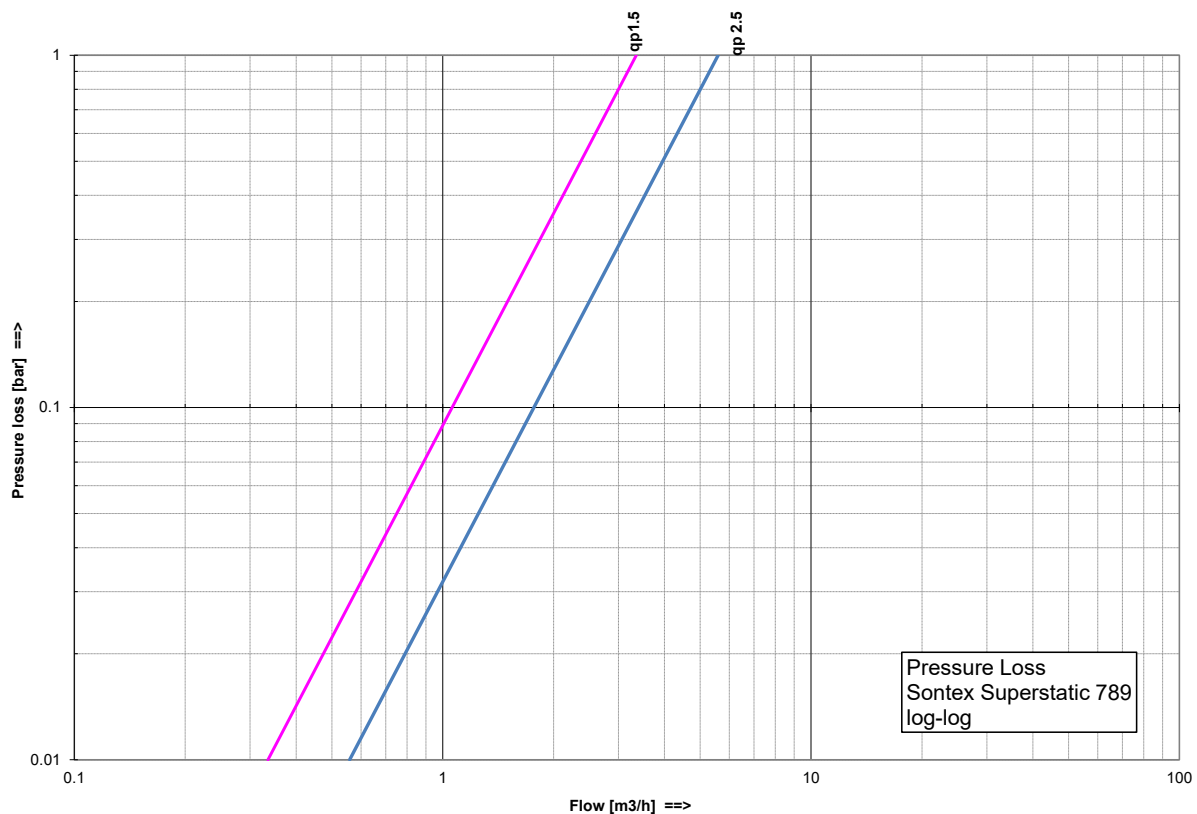

12.3 General technical data

Temperature sensors	<ul style="list-style-type: none"> ■ Temperature sensors 2 wires ■ Diameter ■ Cables lenght 	Pt1000 ø 5, ø 5.2 , ø 6 mm 1.5 m
Measurement	<ul style="list-style-type: none"> ■ Approved temperature range ■ Approved long term operating temperature ■ Differential range ■ Response limit ■ Temperature resolution (display) ■ Temperature resolution ΔT (display) ■ Temperature measurement cycle at nominal flow ■ Volume measurement cycle 	0° ...110°C 5°... 90°C 3...75 K 0.5 K 0.1°C 0.01 K 20 seconds permanent
Calculator	<ul style="list-style-type: none"> ■ Environment class ■ Mechanics ■ Electronics ■ Battery protection class ■ Protection class ■ Cable length between flow sensor and calculator ■ Operating temperature (electronic circuits) ■ Operating temperature (version with radio) ■ Storage and transport temperature 	C M1 E1 III IP65 0.6 m 5...55°C 5...40°C -10...60°C (dry environment)
Display & Display units	<ul style="list-style-type: none"> ■ 8-digits LCD ■ Energy ■ Volume ■ Additional pulse inputs ■ Temperature ■ Δ Temperature 	kWh, MWh, GJ m ³ Volume or pulses °C K
Power supply	<ul style="list-style-type: none"> ■ 3 VDC Lithium Battery 	6+ 1 or 12+ 1 years
Radio communication	<p>Sontex Radio</p> <ul style="list-style-type: none"> ■ Frequency ■ Communication ■ Protocol ■ Encryption ■ Transmission power ■ Transmission interval <p>wM-Bus</p> <ul style="list-style-type: none"> ■ Frequency ■ Communication ■ Protocol ■ Encryption ■ Transmission power ■ Transmission interval <p>LoRaWAN®</p> <ul style="list-style-type: none"> ■ Frequency ■ Communication ■ Protocol ■ Encryption ■ Transmission power ■ Transmission interval ■ Uplink / Downlink 	<p>433.82 MHz bidirectional Radian 0 AES 128 10 mW (10 dBm) on request</p> <p>868.95 MHz unidirectional wM-Bus EN13757-4 AES 128 25 mW (14 dBm) Standard 120 sec. (Mode T1, C1 encryption mode 5, 7), 24/24 or 12/24 (Walk-by), 7/7</p> <p>EU868 bidirectional class A according EN60870-5 AES 128 25 mW (14 dBm) from 1h to 4h depending on the network data coded according to EN60870-5 (M-Bus)</p>
Pulse output	<ul style="list-style-type: none"> ■ Open drain (MOS Transistor) Vccmax : 35 VDC ; Iccmax : 25 mA 	1 Hz, 500 ms
Pulse input with a dry contact	<ul style="list-style-type: none"> ■ Power supply internal ■ Rpull UP internal ■ Pulse factor 	2.3 VDC 2 MΩ 0...999.999 m ³ /pulse or without unit
Powered by M-Bus line	<ul style="list-style-type: none"> ■ 1 device = 2M-Bus charges 	max 2 x 1.5 mA
Metrological class		EN 1434 class 2
Examination type	<ul style="list-style-type: none"> ■ Heating ■ Cooling 	CH-MI004-13019 DE-16-M-PTB-0084

13. Declaration of Conformity



Sontex hereby declares that the Superstatic 789 complies with the Directives MID 2014/32/EU and RED 2014/53EU,



and with the UK Conformity Assessment

The Declaration of Conformity are available at the following link:



Technical support

For technical support contact your local Sontex agent or Sontex SA directly.

Hotline Sontex:

support@sontex.ch

+41 32 488 30 04

Technical modifications subject to change without notice



Sontex SA

Rue de la Gare 27
CH-2605 Sonceboz

Tel. +41 32 488 30 00
sontex@sontex.ch

www.sontex.ch